

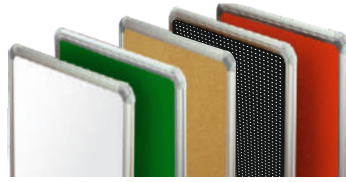

AN ISO 9001 : 2015
REGISTRATION NO.: MAH / Q-1501/C2



ALKOSIGN®

WRITING & DISPLAY SYSTEMS

SINCE 1992

The biggest & only manufacturers of top quality Writing & Display Systems in India.



Introducing **NEW** Innovative Updown & Sliding Writing Boards

- ◆ Innovative Updown & Sliding Writing Boards
- ◆ Notice Boards
- ◆ Benches and Desks
- ◆ White Dry Wipe / Green Chalk Boards
- ◆ Grooved Boards
- ◆ Display Boards
- ◆ Stands & Accessories



NEW
Benches &
Desks



www.alkosign.com

2017/18-S

ALKOSIGN

The only **ISO 9001-2015 COMPANY** is the biggest manufacturers of Writing & Display Systems in India. We welcome you to the exciting new **MODERN CONCEPT IN WRITING & DISPLAY SYSTEMS**

We have the best of the machines from Europe & are using **HOT POWER PRESSING technology**. The manufacturing is semi automated & the only one of its kind in India.

Since the inception of the company in 1992 our sales in the local as well as the export market have increased many times over.

Our success has been due to strict quality control, use of best quality raw materials, good packaging and none the least our vast marketing network.

We are proud to introduce the latest Patented products to keep you tuned with the international scenario in this millennium.

The concept of innovative **UPDOWN** and **SLIDING BOARDS** for schools and colleges is introduced for the first time in India by **ALKOSIGN**.

We have supplied these to many schools and IIM colleges in India.



▶ DESKS FOR CHILDREN	3
▶ SCHOOL & COLLEGE BENCHES	4
▶ MANUAL UP DOWN BOARDS SYSTEM	5
▶ MOTORISED DEPENDENT UP DOWN BOARDS	6
▶ MOTORISED INDEPENDENT UP DOWN BOARDS	7
▶ HORIZONTAL SLIDING BOARDS	8
▶ WRITING SURFACES FOR ASTRA WRITING BOARDS	9
▶ ASTRA CHROME SUPER BOARDS	10
▶ ASTRA CHROME PLUS BOARDS	11
▶ ASTRA CHROME WRITE BOARDS	12
▶ ASTRA FELT / FABRIC NOTICE BOARD	13
▶ FABRIC MAGNETIC PIN UP NOTICE BOARDS	14
▶ ASTRA COMBINATION / CORK BOARDS	15
▶ ACRYLIC COVER NOTICE BOARDS	16
▶ SLIDING GLASS COVER PIN BOARDS	16
▶ EXECUTIVE GLASS WRITING BOARDS	17
▶ ASTRA EXHIBITION DISPLAY SYSTEMS	18-19
▶ LOBBY INFORMATION BOARDS / MAGAZINE STANDS	20
▶ ASTRA FIXED BOARD STANDS / REVOLVING BOARD STANDS	21
▶ ASTRA THREE & FOUR LEGGED STEEL STANDS	22
▶ FLIP CHART BOARDS / HOLDERS / PAPERS	22
▶ CONVENIENT FOLDING BOARDS & STANDS	23
▶ STANDS FOR BOARDS	24
▶ THREE LEGGED STEEL STAND / HANGING BOARDS	25
▶ STEEL BACK KEY CABINETS	26
▶ SLIDING COVER GLASS STEEL BACK KEY CABINETS	27
▶ ASTRA GROOVED FELT BOARDS / PEDESTAL STANDS	28-29
▶ ASTRA PEG BOARDS	30
▶ ENGLISH LETTERS & FIGURES	31
▶ FIRST AID BOX	32
▶ SMALL PARTS STORAGE BOX	33
▶ KEY BOX	34
▶ LETTER BOX	35
▶ MAGNETS	36
▶ ASTRA WRITING BOARD ACCESSORIES	37-38
▶ WRITING DESK	37
▶ YEARLY / MONTHLY / WEEKLY PLANNERS	39



Desks for Children

Alkosisign as a norm always develops & manufactures innovative products that are of good quality and reasonable price since 1992. In that endeavour Alkosisign introduces **BRAINEE™** range of school furniture which are strong sturdy and comfortable for students.



series

Desks

Now no more sitting on the floor with books on the lap. Desks for children are made in two sizes small and big. Tops are prelam MDF 18mm thick with PVC edge banding. All corners are well rounded. Steel frame is of heavy gauge oval pipe of size 35mm x 15mm with plastic shoes.

Small Desk

- ▶ Art No.: ASD
- ▶ Size : L 680mm x B 355mm x H 270mm
- ▶ Colours available : Red and Blue

Specify the colour required

Big Desk

- ▶ Art No.: ABD
- ▶ Size : L 740mm x B 355mm x H 310mm
- ▶ Colours available : Red and Blue

Specify the colour required



Desk Colours ● ●



Before



After



School & College Benches

School & college benches for students are made in two sizes as per their age group. They are made from 25mm round pipe powder coated white colour, sturdy design for long use. Bag hanger, angled back rest and strong shelves are provided in all benches. All the tops and shelves are made from 18mm pre laminated MDF board with rounded corners and PVC edge banding all around. Four plastic levelling shoes are provided.



series



Medium Bench
Dual Seater



Big Bench
Single seater

Bench Colours



Big Bench- Dual seater ▶

- ▶ Art No.: **ASCB-BDS**
 - ▶ Size : **L 1050mm x B 890mm x H 760mm**
 - ▶ Colours available : **Red , Blue & Brown**
- Specify the colour required

◀ Medium Bench - Dual Seater

- ▶ Art No.: **ASCB-MDS**
- ▶ Size : **L 1000mm x B 820mm x H 700mm**
- ▶ Colours available : **Red , Blue & Brown**

Specify the colour required

Big Bench - Single seater

- ▶ Art No.: **ASCB-BSS**
- ▶ Size : **L 600mm x B 890mm x H 760mm**
- ▶ Colours available : **Red , Blue & Brown**

Specify the colour required



Bench Colours



Big
Bench Dual seater



Improved Noiseless Manual UP DOWN BOARDS SYSTEM

In this system the two boards are dependent on each other. When one board is pushed up manually the other board comes down. In classrooms when one board is fully written it is pushed up and the lecturer can write on the second board. The continuity is not lost. Writing surface is porcelain ceramic enameled steel surface . White colours for writing with dry wipe markers and green for writing with chalk.



Standard Size of White or Green Board
2400mm x 2400mm. It consists of two boards.
Each board of size 1200mm x 2400mm

Manual porcelain ceramic white Up Down board for dry wipe marker.

- Art No : AUD M C 240 x 240
- Art No : AUD M C 240 x 300
- Art No : AUD M C 240 x 360

Manual porcelain ceramic green Up Down Board for writing with chalk.

- Art No : AUD M CC 240 x 240
- Art No : AUD M CC 240 x 300
- Art No : AUD M CC 240 x 360

- ▶ Aluminium sections are silver colour anodised.
- ▶ Special request for champagne colour anodizing or powder coating can be considered.
- ▶ Other sizes and combinations as per request.
- ▶ Fitting instructions provided.

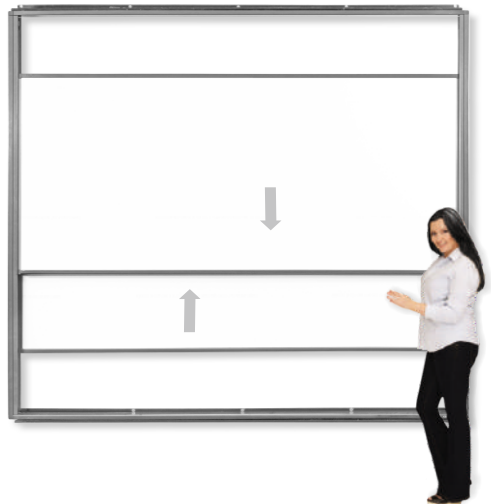



**Improved Noiseless
Motorised Dependent
UP DOWN BOARDS**



Movement of boards are dependent on each other. When one board goes up the other comes down. Special imported tubular motors are used for their movement. Remote control (R) or electric switch control (E) can be provided in the motors for movement of the boards.



series

Standard size:

2400mm x 2400mm it consists of two boards.

Each board of size 1200mm x 2400mm

Motorised Dependent porcelain ceramic white up down board for dry wipe markers

Art No : **AUD D C 240 x 240**

Art No : **AUD D C 240 x 300**

Art No : **AUD D C 240 x 360**

Please specify if remote control (R) or electric switch (E) is required

Motorised Dependent porcelain ceramic Green up down board for writing with chalk

Art No ; **AUD D CC 240 x 240**

Art No : **AUD D CC 240 x 300**

Art No : **AUD D CC 240 x 360**

Please specify if remote control (R) or electric switch (E) is required

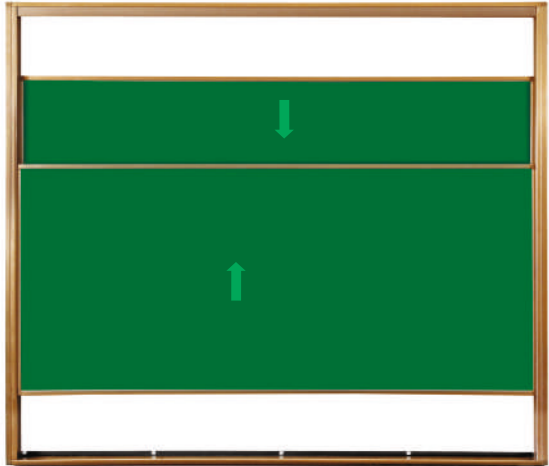

- ▶ Aluminium sections are silver colour anodised.
- ▶ Special request for champagne colour anodising or powder coating can be considered.
- ▶ Other sizes and combinations as per request.
- ▶ Fitting instructions provided.
- ▶ Standard wiring from the top left.
- ▶ Specify if required on the right.



Remote control

NEW

Improved Noiseless Motorised Independent UP DOWN BOARDS

In this system the boards move independent of each other. You can move the boards up and down independently. Special imported tubular motors are used for the movement. Remote control (R) or electric switch control (E) can be provided in the motors for up & down movement.

**series**

Standard size :

2400mm x 2400mm it consists of two boards.**Each board of size 1200mm x 2400mm**

**Motorised Independent porcelain ceramic
white up down board for dry wipe markers**

Art No : **AUD IC 240 x 240**Art No : **AUD IC 240 x 300**Art No : **AUD IC 240 x 360**

Please specify if remote control (R)
or electric switch (E) is required

**Motorised Independent porcelain ceramic
Green up down board for writing with chalk**

Art No : **AUD ICC 240 x 240**Art No : **AUD ICC 240 x 300**Art No : **AUD ICC 240 x 360**

Please specify if remote control (R)
or electric switch (E) is required

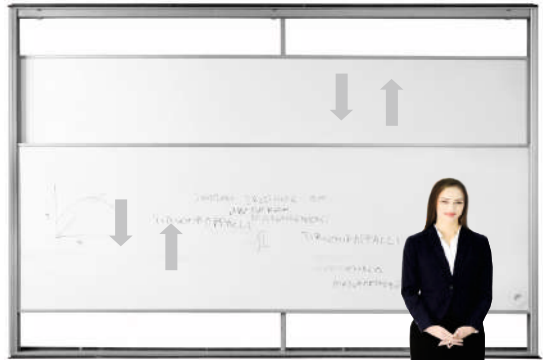

- ▶ Aluminium sections are silver colour anodised
- ▶ Special request for champagne colour anodising or powder coating can be considered.
- ▶ Other sizes and combinations as per request.
- ▶ Fitting instructions provided.
- ▶ Standard wiring from the top left.
- ▶ Specify if required on the right.

**Remote control**

Horizontal Sliding Board System

In this system the boards slide on bearings in the tracks .
The board at the back is fixed and the other board can slide from one end to the other. Porcelain Ceramic writing surface in white for drywipe markers or green for writing with chalk is available.



Board Size : 1200 x 3600 mm
Two sliding boards of size : 1200mm x 1200mm
and one full size fixed board at the back.

Art No.: **AHSBC 120360** (1200mm x 3600mm)
for writing with dry wipe markers.

Art No.: **AHSBC 120360** (1200mm x 3600mm)
for writing with chalk



When the small boards are on the sides, the center can also be used for projection purpose.
Alternatively an interactive board can be fitted in the center with two fixed writing boards on the sides. The front two sliding boards can cover the interactive board when not in use.

Other sizes and combinations
as per request.





SUPER QUALITY ☆☆☆☆☆ long term intensive use.

- ▶ Ceramic (Porcelain Enamel) fused at high temperature on steel surface has a very high surface hardness & excellent abrasion resistance.
- ▶ Twenty five years guarantee for the surface under normal use.
- ▶ Semi matt surface can be used as a screen for OHP also.
- ▶ Accepts magnets.

Available in white color for writing with dry wipe markers and green for writing with chalk.

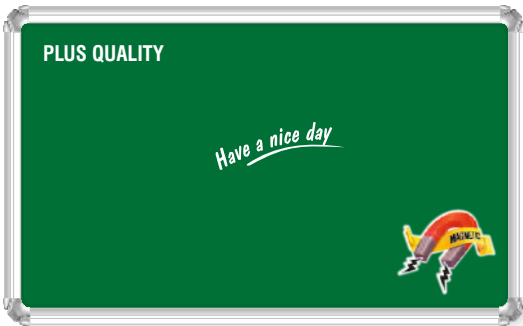

PLUS QUALITY ☆☆☆☆☆ Long term regular use.

- ▶ Triple coated steel surface with top coat of acrylic resin over a galvanized steel base.
- ▶ Surface is smooth, glossy and permits easy writing and erasing.
- ▶ It is a good economical surface.
- ▶ Accepts magnets.

Available in white color for writing with dry wipe markers and green for writing with chalk.



WRITE QUALITY ☆☆☆☆☆ regular use.

- ▶ It is the most economical dry wipe or chalk writing surface. It is highly durable. High pressure special white melamine surface for writing with dry wipe markers and **special coated green laminate surface** for writing with chalk.
- ▶ **Does not accept magnets.**



ASTRA CHROME SUPER BOARDS

- ▶ White ceramic surface for dry wipe markers.
- ▶ Green ceramic surface for writing with chalk.
- ▶ Ceramic enameled Steel surface.
- ▶ Scratch resistant , no ghosting.
- ▶ Surface with 25 years warranty.
- ▶ Framed in double sided curved Astra section gives good strength.
- ▶ **CHROME PLATED** plastic corners- good aesthetics.
- ▶ Chrome plated metal corner brackets for easy fixing on the wall in landscape or portrait.
- ▶ Fixing screw and anchor plugs provided.
- ▶ Accepts magnets.
- ▶ Magnets, pen trays and other accessories order separately.

STANDARD SIZE (In mm Approx.)	CERAMIC WHITE DRY WIPE BOARD ART NO.	CERAMIC GREEN CHALK BOARD ART NO.
300 x 450	ATRS 3045	ATRSC 3045
300 X 600	ATRS 3060	ATRSC 3060
450 X 600	ATRS 4560	ATRSC 4560
450 X 900	ATRS 4590	ATRSC 4590
600 X 600	ATRS 6060	ATRSC 6060
600 X 900	ATRS 6090	ATRSC 6090
600 X 1200	ATRS 60120	ATRSC 60120
600 X 1800	ATRS 60180	ATRSC 60180
900 X 900	ATRS 9090	ATRSC 9090
900 X 1200	ATRS 90120	ATRSC 90120
900 X 1500	ATRS 90150	ATRSC 90150
900 X 1800	ATRS 90180	ATRSC 90180
1200 X 1500	ATRS 120150	ATRSC 120150
1200 X 1800	ATRS 120180	ATRSC 120180
1200 X 2400	ATRS 120240	ATRSC 120240
1200 X 3000	ATRS 120300	ATRSC 120300
1200 X 3600	ATRS 120360	ATRSC 120360





- ▶ Triple coated steel surface with a top coat of acrylic resin over a galvanized steel base.
- ▶ Surface smooth & glossy with good surface hardness.
- ▶ Resists scratches.
- ▶ Permits easy writing & erasing.
- ▶ It does not rust & is as durable as porcelain enamel sheet but at a lower cost .
- ▶ 50mm X 50mm faint grids available.
- ▶ Facilitates writing & drawing graphs.

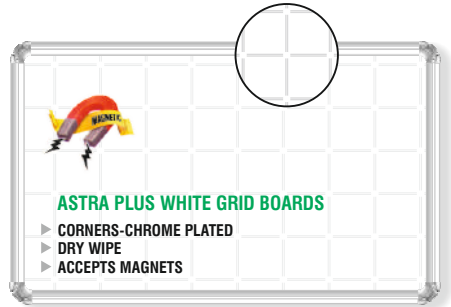

ASTRA CHROME PLUS BOARDS

STANDARD SIZE (In mm Approx.)	PLUS WHITE BOARD ART NO.	PLUS CHALK GREEN BOARD ART NO.	PLUS GRID WHITE BOARD ART NO.	PLUS CHALK GREEN GRID BOARD ART NO.
300 x 450	ATRP 3045	ATRPC 3045	ATRPG 3045	ATRPCG 3045
300 X 600	ATRP 3060	ATRPC 3060	ATRPG 3060	ATRPCG 3060
450 X 600	ATRP 4560	ATRPC 4560	ATRPG 4560	ATRPCG 4560
450 X 900	ATRP 4590	ATRPC 4590	ATRPG 4590	ATRPCG 4590
600 X 600	ATRP 6060	ATRPC 6060	ATRPG 6060	ATRPCG 6060
600 X 900	ATRP 6090	ATRPC 6090	ATRPG 6090	ATRPCG 6090
600 X 1200	ATRP 60120	ATRPC 60120	ATRPG 60120	ATRPCG 60120
600 X 1800	ATRP 60180	ATRPC 60180	ATRPG 60180	ATRPCG 60180
900 X 900	ATRP 9090	ATRPC 9090	ATRPG 9090	ATRPCG 9090
900 X 1200	ATRP 90120	ATRPC 90120	ATRPG 90120	ATRPCG 90120
900 X 1500	ATRP 90150	ATRPC 90150	ATRPG 90150	ATRPCG 90150
900 X 1800	ATRP 90180	ATRPC 90180	ATRPG 90180	ATRPCG 90180
1200 X 1500	ATRP 120150	ATRPC 120150	ATRPG 120150	ATRPCG 120150
1200 X 1800	ATRP 120180	ATRPC 120180	ATRPG 120180	ATRPCG 120180
1200 X 2400	ATRP 120240	ATRPC 120240	ATRPG 120240	ATRPCG 120240
1200 X 3000	ATRP 120300	ATRPC 120300	ATRPG 120300	ATRPCG 120300
1200 X 3600	ATRP 120360	ATRPC 120360	ATRPG 120360	ATRPCG 120360

BIGGER & SPECIAL SIZES BOARDS & SCREEN PRINTED GRID BOARDS AVAILABLE



Astra Write White Board

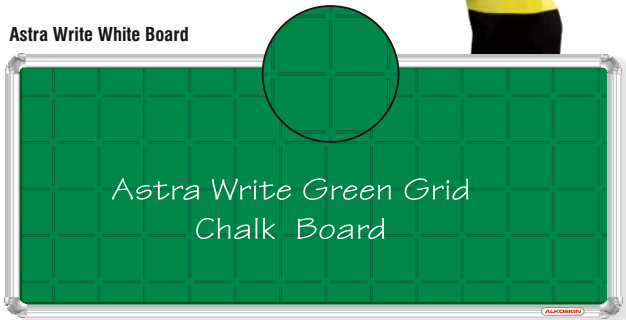

Astra Write Green Grid Chalk Board

- ▶ Most economical dry wipe / chalk writing boards.
- ▶ Suitable for writing with dry wipe markers or with chalk
- ▶ Special high pressure melamine surface.
- ▶ Highly durable for regular use.
- ▶ Does not accept magnets.
- ▶ 50mm X 50mm double line faint grids.



ASTRA CHROME WRITE BOARDS

STANDARD SIZE (In mm Approx.)	WRITE WHITE BOARD ART NO.	WRITE GREEN CHALK BOARD ART NO.	WRITE WHITE GRID BOARD ART NO.	WRITE GREEN CHALK GRID BOARD ART NO.
300 x 450	ATRW 3045	ATRCW 3045	ATRWG 3045	ATRWCG 3045
300 X 600	ATRW 3060	ATRCW 3060	ATRWG 3060	ATRWCG 3060
450 X 600	ATRW 4560	ATRCW 4560	ATRWG 4560	ATRWCG 4560
450 X 900	ATRW 4590	ATRCW 4590	ATRWG 4590	ATRWCG 4590
600 X 600	ATRW 6060	ATRCW 6060	ATRWG 6060	ATRWCG 6060
600 X 900	ATRW 6090	ATRCW 6090	ATRWG 6090	ATRWCG 6090
600 X 1200	ATRW 60120	ATRCW 60120	ATRWG 60120	ATRWCG 60120
600 X 1800	ATRW 60180	ATRCW 60180	ATRWG 60180	ATRWCG 60180
900 X 900	ATRW 9090	ATRCW 9090	ATRWG 9090	ATRWCG 9090
900 X 1200	ATRW 90120	ATRCW 90120	ATRWG 90120	ATRWCG 90120
900 X 1500	ATRW 90150	ATRCW 90150	ATRWG 90150	ATRWCG 90150
900 X 1800	ATRW 90180	ATRCW 90180	ATRWG 90180	ATRWCG 90180
1200 X 1500	ATRW 120150	ATRCW 120150	ATRWG 120150	ATRWCG 120150
1200 X 1800	ATRW 120180	ATRCW 120180	ATRWG 120180	ATRWCG 120180
1200 X 2400	ATRW 120240	ATRCW 120240	ATRWG 120240	ATRWCG 120240
1200 X 3000	ATRW 120300	ATRCW 120300	ATRWG 120300	ATRWCG 120300
1200 X 3600	ATRW 120360	ATRCW 120360	ATRWG 120360	ATRWCG 120360

BIGGER & SPECIAL SIZES BOARDS & SCREEN PRINTED GRID BOARDS AVAILABLE

ASTRA FELT NOTICE BOARDS

- ▶ Framed in double sided curved Astra aluminum section, matt silver anodized.
- ▶ Direct easy fixing of board to the wall.
- ▶ Six different colours of felt available.
- ▶ Use Push Pins, Map tacks ect. Push Pins available.
- ▶ Colours : Green, Red, Blue, Grey, Maroon, Beige



ASTRA FABRIC NOTICE BOARDS

- ▶ Special fabric enhances the decor of the office or any establishment.
- ▶ Four different shades available.
- ▶ Use push pins.
- ▶ Colours of Fabrics : Grey, Beige, Blue, Brown



ASTRA FELT / FABRIC NOTICE BOARDS

STANDARD SIZE (In mm Approx.)	FELT COVERED NOTICE BOARDS ART NO.	FABRIC NOTICE BOARDS ART NO.
300 x 450	ATRNB-F 3045	ATRNB-F 3045
300 X 600	ATRNB-F 3060	ATRNB-F 3060
450 X 600	ATRNB-F 4560	ATRNB-F 4560
450 X 900	ATRNB-F 4590	ATRNB-F 4590
600 X 600	ATRNB-F 6060	ATRNB-F 6060
600 X 900	ATRNB-F 6090	ATRNB-F 6090
600 X 1200	ATRNB-F 60120	ATRNB-F 60120
600 X 1800	ATRNB-F 60180	ATRNB-F 60180
900 X 900	ATRNB-F 9090	ATRNB-F 9090
900 X 1200	ATRNB-F 90120	ATRNB-F 90120
900 X 1500	ATRNB-F 90150	ATRNB-F 90150
900 X 1800	ATRNB-F 90180	ATRNB-F 90180
900 X 2400	ATRNB-F 90240	ATRNB-F 90240
1200 X 1200	ATRNB-F 120120	ATRNB-F 120120
1200 X 1500	ATRNB-F 120150	ATRNB-F 120150
1200 X 1800	ATRNB-F 120180	ATRNB-F 120180
1200 X 2400	ATRNB-F 120240	ATRNB-F 120240
1200 X 3000	ATRNB-F 120300	ATRNB-F 120300



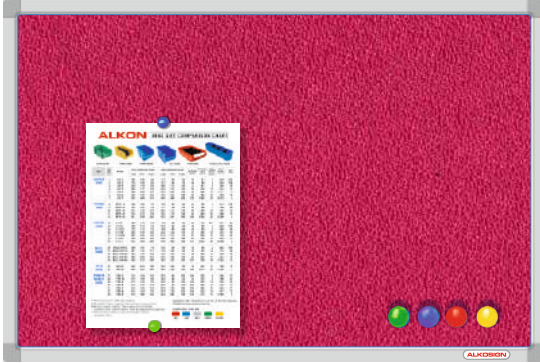

For push pins and Magnets versatile dual functional design with durable fabric surface easily and firmly tack documents, notes, photos, with push pin and magnets.

- ▶ Unique modern look.
- ▶ Designed to use with push pins and neodym high power magnets.
- ▶ 4 magnets (20mm) supplied with board.
- ▶ Helps to keep your important documents undamaged.
- ▶ Anodised aluminium frame with chrome plated corners.
- ▶ Steel corners provided at the back for hanging on the wall.
- ▶ Push pins and extra Magnets order separately.

Colours : shown as below

Available in two sizes :

Art No.: AURMPBF 6090

Size : 600mm x 900mm

Art No.: AURMPBF 90120

Size : 900mm x 1200mm

Colours available for Fabrics & Magnetic Pin Up Notice Board



Maroon-PKC-1031



Brown-PKC-1056



Green-PKC-1042



Hot Pink-RC-61



Blue-RC-55

ASTRA COMBINATION BOARDS ASTRA PLUS + FELT

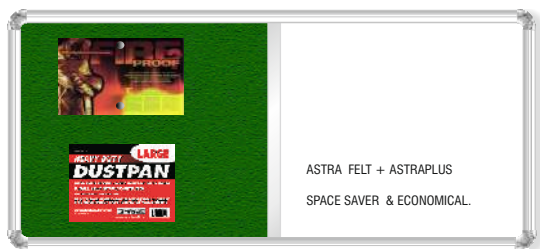

- ▶ Dual purpose Board half plus + half Felt.
- ▶ Felt colors :
Green , Red, Blue, Grey, Maroon or Beige.
- ▶ Use push pin & dry wipe markers.

ASTRA COMBINATION BOARDS ASTRA WRITE + FELT

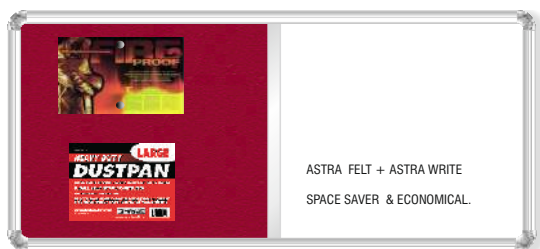

- ▶ Dual purpose Board half write + half Felt.
- ▶ Felt colors :
Green , Red, Blue, Grey, Maroon or Beige.
- ▶ Use push pin & dry wipe markers.



ASTRA CORK NOTICE BOARDS

- ▶ Surface cork sheet.
- ▶ Use push pins.

STANDARD SIZE (In mm Approx.)	FELT + PLUS BOARDS ART NO.	STANDARD SIZE (In mm Approx.)	WRITE + FELT BOARDS ART NO.	STANDARD SIZE (In mm Approx.)	ASTRA CORK NOTICE BOARDS ART NO.
600 X 900	ATRCBMF 6090	600 X 900	ATRCBWF 6090	300 x 450	ATRNBC 3045
600 X 1200	ATRCBMF 60120	600 X 1200	ATRCBWF 60120	300 X 600	ATRNBC 3060
600 X 1800	ATRCBMF 60180	600 X 1800	ATRCBWF 60180	450 X 600	ATRNBC 4560
900 X 900	ATRCBMF 9090	900 X 900	ATRCBWF 9090	450 X 900	ATRNBC 4590
900 X 1200	ATRCBMF 90120	900 X 1200	ATRCBWF 90120	600 X 900	ATRNBC 6090
900 X 1500	ATRCBMF 90150	900 X 1500	ATRCBWF 90150	900 X 900	ATRNBC 9090
900 X 1800	ATRCBMF 90180	900 X 1800	ATRCBWF 90180	900 X 1200	ATRNBC 90120
900 X 2400	ATRCBMF 90240	900 X 2400	ATRCBWF 90240	900 X 1800	ATRNBC 90180
900 X 3000	ATRCBMF 90300	900 X 3000	ATRCBWF 90300	1200 X 1200	ATRNBC 120120
1200 X 1200	ATRCBMF 120120	1200 X 1200	ATRCBWF 120120	1200 X 1500	ATRNBC 120150
1200 X 1500	ATRCBMF 120150	1200 X 1500	ATRCBWF 120150	1200 X 1800	ATRNBC 120180
1200 X 1800	ATRCBMF 120180	1200 X 1800	ATRCBWF 120180	1200 X 2400	ATRNBC 120240
1200 X 2400	ATRCBMF 120240	1200 X 2400	ATRCBWF 120240		
1200 X 3000	ATRCBMF 120300	1200 X 3000	ATRCBWF 120300		



ALKOSIGN COVER NOTICE BOARDS

- ▶ Choice of six felt colors Green, Red, Blue, Grey, Maroon & Beige.
- ▶ Use push pins to pin notices.
- ▶ Soft board backing.
- ▶ Front cover with aluminum framed acrylic sheet - lockable.
- ▶ Provided with 2 keys.
- ▶ For indoor use.
- ▶ Size above 90180 will have 2 or 3 doors (On Request)

STANDARD SIZE (In mm Approx.)	ACRYLIC COVER NOTICE BOARDS ART NO.
450 x 600	NBFC 4560
600 X 900	NBFC 6090
600 X 1200	NBFC 60120
900 X 900	NBFC 9090
900 X 1200	NBFC 90120
900 X 1500	NBFC 90150
900 X 1800	NBFC 90180

SLIDING GLASS COVER PIN BOARDS

- ▶ Blue Colour Special plastic Foam.
- ▶ Easy to pin Notices.
- ▶ Waterproof surface.
- ▶ Sliding Glass moves easily on Bearings.
- ▶ Lockable-keep messages visible & protected.
- ▶ Strong Aluminium frame 30mm X 50mm.
- ▶ Steel corners provided at the back to hang on the wall.



STANDARD SIZE (In mm Approx.)	SLIDING COVER NOTICE BOARD ART NO.
600 X 900	ASGPB 6090
900 X 1200	ASGPB 90120
1200 X 1500	ASGPB 120150
1200 X 1800	ASGPB 120180

SLIDING GLASS COVER MAGNETIC WHITE NOTICE BOARD

- ▶ White magnetic surface.
- ▶ Use magnets to put up notice & messages.
- ▶ Sliding Glass moves easily on Bearings.
- ▶ Lockable-keep messages visible & protected.
- ▶ Strong Aluminium frame 30mm X 50mm.
- ▶ Steel corners provided at the back to hang on the wall.



STANDARD SIZE (In mm Approx.)	SLIDING MAG. WHITE BOARD ART NO.
600 X 900	ASGMB 6090
900 X 1200	ASGMB 90120
1200 X 1500	ASGMB 120150
1200 X 1800	ASGMB 120180

EXECUTIVE GLASS WRITING BOARDS

- ▶ The most elegant writing board for executives.
- ▶ Prepainted steel writing surface laminated on glass.
- ▶ Can hold magnets.
- ▶ Magnetic pen tray and duster to be ordered separately.
- ▶ Glass sheet 8mm thick fits on the wall with four stainless steel holders.

ART NO.: AGWB 90120 Size : 900mm x 1200mm
ART NO.: AGWB 90150 Size : 900mm x 1500mm



- ▶ Easy to assemble modular system specially for exhibitions or reception areas.
 - ▶ Heavy bases keep the system stable.
 - ▶ Dry wipe magnetic panels at the top can be used for messages or information.
 - ▶ Other Panels felt / Plus available.
 - ▶ Multi-position fitting enables placement of panels at different angles to suit available space.
 - ▶ Specify Felt Colors : Green, Red, Maroon, Grey, Beige and Blue.
- Other combination on request.



Unlimited Combinations

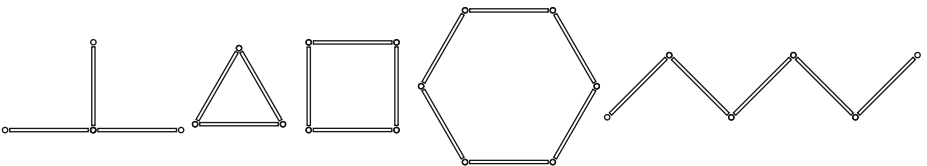

Specify Felt Colors : **Green, Red, Maroon, Grey, Beige and Blue**

The system is available in following configuration : (Base, Vertical Pipes & Fittings Included.)

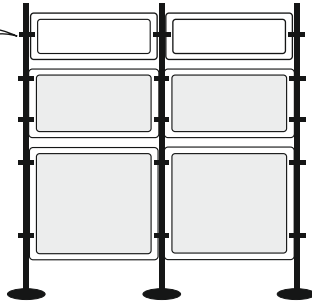
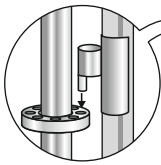

Set No. 1

2 Nos. ATRP 2090

2 Nos. ATRNBF 6090

2 Nos. ATRNBF 9090

Size : Height 1860mm, Width 1900mm.

ART NO.: AEDS- 1

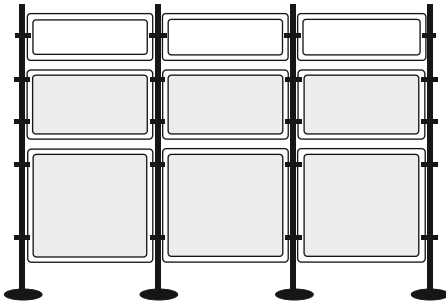

Set No. 2

3 Nos. ATRP 2090

3 Nos. ATRNBF 6090

3 Nos. ATRNBF 9090

Size : Height 1860mm, Width 2850mm.

ART NO.: AEDS- 2

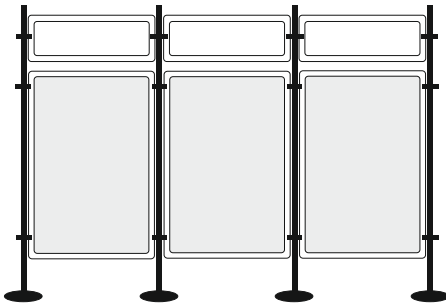

Set No. 3

3 Nos. ATRP 2090

3 Nos. ATRNBF 15090

Size : Height 1860mm, Width 2850mm

ART NO.: AEDS- 3

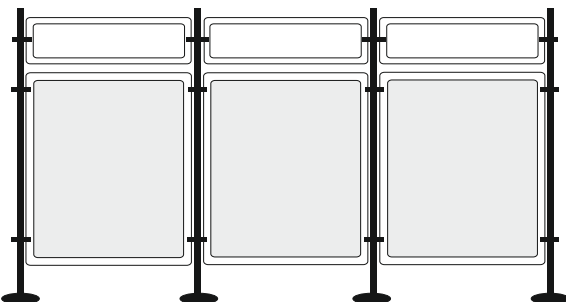

Set No. 4

3 Nos. ATRP 20120

3 Nos. ATRNBF 150120

Size : Height 1860mm, Width 3750mm

ART NO.: AEDS- 4



ART NO.: ASLIB-A

◀ **STEEL LOBBY INFORMATION BOARD WITH STAND**

▶ Steel framed grooved lobby board with angular cut steel pipe stand Matt black powder coated.

Art No.: ASLIB-A (Angular)

▶ Golden letters and figures of 18mm, 24mm & 36mm sizes available for display of programs,

▶ Messages Order separately. Grooved board colours standard Red, Maroon & Black also order colour as require.

Size of Board : 560mm x 860mm

Total Dimension :

1590mm (H) x 670mm (W) x 540mm (D)



LECTERN / PODIUM ▶

- ▶ Lecture Confidently.
- ▶ Very economical Lectern.
- ▶ Light weight but strong construction.
- ▶ Big table top Size : 590mm x 450mm
- ▶ Extra large compartment.
- ▶ Four Levelling Screws.
- ▶ Colour Brown.
- ▶ Brown Fabric board in front.

Size : 590mm x 450mm x 1170 mm.

Art No.: ASLEL



◀ **ELEGANT NEWS PAPER STAND**

▶ Three tier.

STAND SIZE : W 600mm x H 1090mm x D 600mm

▶ Steel Black powder coated Black colour.

Art No.: ASNPS

STEEL MAGAZINE STAND ▶

▶ Very convenient and elegant steel black powder coated stand for display of magazines in hotel lobbies.

STAND SIZE : 600mm x 500mm x 1290mm.

Art No.: ASMS



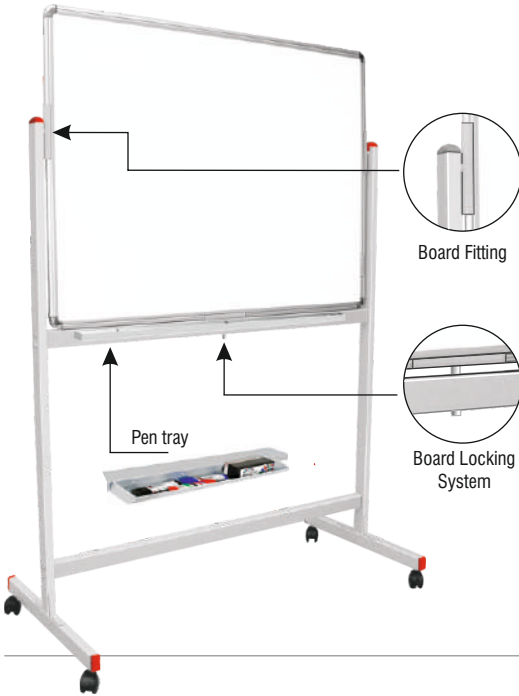

◀ **ALKOSIGN FIXED BOARD STAND**

- ▶ Suitable for ASTRA writing board.
- ▶ Use fixed double sided or single sided boards.
- ▶ Stand with heavy duty lockable castors
- ▶ Packed in CKD condition.
- ▶ Can be easily assembled.
- ▶ Pen tray provided.
- ▶ Not recommended for felt board.

Art No.: AWBS/F 12090

For Board 1200mm X 900mm height.

Art No.: AWBS/F 180120

For board 1800mm x 1200mm Height.
Order Board separately.

REVOLVING BOARD STANDS ▶

- ▶ Suitable for ASTRA Writing Boards.
- ▶ Use double sided boards which can revolve on stand and can be locked in either position with positive locking system.
- ▶ Stand provided with heavy duty lockable castors.
- ▶ Packed in CKD condition.
- ▶ Can be easily assembled.
- ▶ Pen tray provided.
- ▶ Not recommended for felt board.

ART NO. AWBS/R 9060 for boards of 900mm width X 600mm height.

ART NO. AWBS/R 12090 for boards 1200mm width X 900mm height.

ART NO. AWBS/R 180120 for boards 1800mm width X 1200mm height.

Double sided boards add **DS** to the above
Example **ASTRA PLUS DOUBLE SIDED BOARDS**

ART NO. ATR PDS 180120

Order double sided boards separately. Bigger sizes of revolving stands available on request.





◀ **THREE LEGGED STEEL STANDS**

- ▶ Suitable for ASTRA Writing Boards.
- ▶ Three legged steel stands.
- ▶ Sturdy design.
- ▶ Board rests on clamps with non skid rubber pads.
- ▶ Extra holes for adjusting height.
- ▶ Not recommended for felt board.



Height of stand 1610mm Suitable for boards up to 900mm X 1200mm

Art No.: AWBS/3L/N/ 90120

Order boards separately.

ASTRA FOUR LEGGED STEEL STAND ▶

- ▶ Suitable for ASTRA writing board.
- ▶ Heavy duty four legged stands for big boards.
- ▶ Suitable for ASTRA boards of size upto 1200mm X 1800mm
- ▶ Not recommended for felt board.

Art No.: AWBS /4L 120180

Order board separately.



◀ **FLIP CHART HOLDER**

- ▶ Very economical paper holding system.
- ▶ Made of steel powder coated.
- ▶ Can be fitted on board of Size 700mm X 1000mm (ATRW 70100 or ATRP 70100)

FLIP CHART HOLDER

Art No.:AFCH 60

Order AWBS / 3L 6090 Board & Flip chart paper separately.

FLIP CHART PAPERS

Size : 58.5 cms X 90 cms
Hole centre distance 42 cms.
75 gsm. economy paper
25 paper sheets in one pad

Art No.: AFCP

FOLDING WRITING BOARD

- ▶ Folding board is of size 600mm x 900mm and after folding it becomes 600mm x 450mm
- ▶ Strong carry bag is provided to carry the board conveniently.
- ▶ The surface is pre-painted white for dry wipe markers or green for writing with chalk.

Art No.: ACFBP 6090 for white boards.

Art No.: ACFBPC 6090 for green boards.

TELESCOPIC STAND

- ▶ Telescopic stand becomes half the size when inner pipes are telescoped inside the outer pipes.
- ▶ Convenient strong carry bag is provided to carry the stand.
- ▶ Tray to hold the boards is provided. Size suitable for 600 x 900 boards. Maximum height of stand 1600mm

Art No.: AWBST/3L 6090

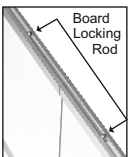



PEDESTAL STAND

- ▶ Consists of a heavy threaded base
 - ▶ Available with or without castors.
 - ▶ Anodised aluminium pipe of 1800 mm length.
 - ▶ Two nylon holders can be fixed on boards to hold the pipe.
 - ▶ Use one stand for boards upto 600mm X 900mm
- Art No.: APS** without castors.
Art No.: APSC with four castors.
 Order boards separately.



◀ **RECEPTION BOARD STAND**

- ▶ Free standing stand for any dry wipe or perforated board.
 - ▶ Ideal for use in Foyers and Reception.
 - ▶ Suitable for 600mm X 900mm boards.
 - ▶ Boards set at a slight angle to make it easily readable.
 - ▶ Strong steel base with levelling screws.
- Art No.: ARBS** stand only
 Order board separately.

LOBBY BOARD WITH STAND ▶

- ▶ Light weight portable unit.
 - ▶ Convenient for directions in lobbies etc.
 - ▶ Can accommodate board size of 300mm x 450mm.
 - ▶ Anodised Aluminium pipe of 1065mm (42") Length.
- Art No.: ALB**
 Heavy threaded base is provided for fixing the pipe





NEW THREE LEGGED STEEL STANDS

- ▶ Suitable for ASTRA Boards.
- ▶ Three legged steel stands.
- ▶ Sturdy design Colour Grey.
- ▶ Board rests on full length **Aluminium channel**.
- ▶ Height adjustable as required.

Height of stand 1600mm
 Suitable for boards up to 900mm X 1200mm

Art No.: AWBS/AL/3L/N

Order boards separately.

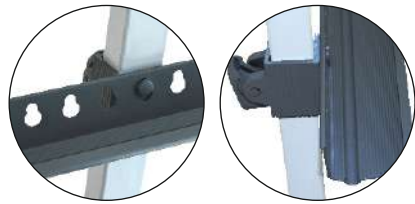

ECONOMICAL HANGING SERIES BOARDS

The most economical boards for regular use
 The surface is either special high pressure laminate white for writing with dry wipe markers or green for writing with chalk in three sizes only.

High Pressure Laminate Boards

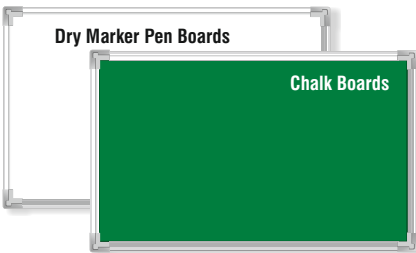

Dry Marker Pen Boards

Art No.: AEHBW 4560

Size : 450mm x 600mm

Art No.: AEHBW 6090

Size : 600mm x 900mm

Art No.: AEHBW 90120

Size : 900mm x 1200mm

Chalk Boards

Art No.: AEHBWC 4560

Size : 450mm x 600mm

Art No.: AEHBWC 6090

Size : 600mm x 900mm

Art No.: AEHBWC 90120

Size : 900mm x 1200mm

NEW ALKOSIGN MULTI MAGNETIC WRITING BOARD

- ▶ Triple coated smooth and glossy steel surface with a top coat of acrylic resin.
- ▶ Includes Dusters and drywipe pen with holder and one magnet.
- ▶ Powder coated blue frame with blue plastic corners.
- ▶ 3 hangers provided to fit in landscape or portrait.



Available in two sizes :

Art No.: AMMWB 3045 Size : 300mm x 450mm

Art No.: AMMWB 4560 Size : 450mm x 600mm

NEW STEEL BACK KEY CABINETS

- ▶ Elegant new design.
- ▶ Complete powder coated steel.
- ▶ Back plate with key holder.
- ▶ Longer Keys can also be hung.
- ▶ Individually numbered key holders included.
- ▶ Acrylic lockable cover.
- ▶ Available for 20, 30, 40, 50 & 100 Keys



KEY CABINETS FOR 100 KEYS



KEY CABINETS FOR 50 KEYS



KEY CABINETS FOR 40 KEYS



KEY CABINETS FOR 30 KEYS



KEY CABINETS FOR 20 KEYS



NO OF KEYS	STANDARD SIZE (In mm. Approx.)	ART NO.
10	282 X 308	ASKB 10
20	310 X 500	ASKB 20
30	410 X 500	ASKB 30
40	520 X 500	ASKB 40
50	620 X 500	ASKB 50
100	620 X 800	ASKB 100

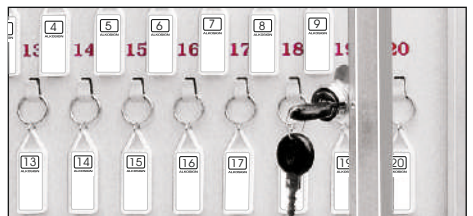

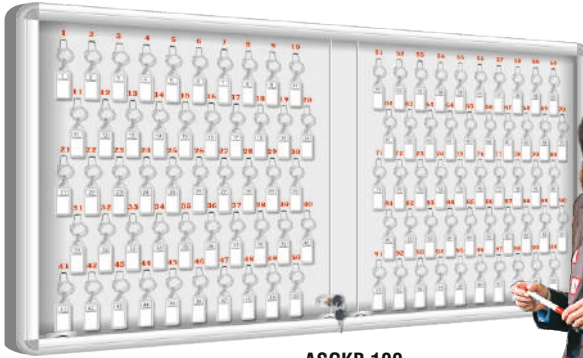

ASGKB 100



ASGKB 48

- ▶ New design with sliding glass.
- ▶ Key numbers printed on steel & on the key holders.
- ▶ Glass cover moves easily on Bearings.
- ▶ Lock with two keys provided for safety.
- ▶ Strong Aluminium frame 30mm X 50mm
- ▶ Available for 48 & 100 keys.
- ▶ Steel corners provided at the back to hang on the wall.

NO OF KEYS	STANDARD SIZE (In mm Approx.)	SLIDING COVER KEY CABINETS ART NO.
48	525 X 700	ASGKB 48
50	630 X 510	ASGKB 50
100	630 X 1020	ASGKB 100

STANDARD ACRYLIC COVER KEY CABINETS

- ▶ Very convenient lockable key storage system.
- ▶ Metal hooks for hanging keys
- ▶ Acrylic lockable cover.
- ▶ Different sizes for 20, 30, 40, 50 & 100 keys.
- ▶ Numbered Key chains provided.
- ▶ Paper slip in key chains for writing.

NO OF KEYS	STANDARD SIZE (In mm. Approx.)	ART NO.
20	310 X 500	AKB 20
30	410 X 500	AKB 30
40	520 X 500	AKB 40
50	620 X 500	AKB 50
100	785 X 900	AKB 100





ALKOSIGN GROOVED FELT BOARDS WITH BEST QUALITY FELT.

- ▶ Suitable for use in Hotels, Reception Area Leisure centers etc.
- ▶ Nine sizes in landscape and Portrait.
- ▶ Golden Anodized frame.
- ▶ Felt colors available : Red, Maroon & Black.



GOLDEN LETTERS & FIGURES FOR GROOVED BOARDS.

- ▶ Golden foiled plastic letters and figures fit easily in the grooves.
- ▶ Three sizes 36mm, 24mm & 18mm

LETTERS SET OFF 112

SIZE OF LETTERS (In mm Approx.)	ART NO.
36 mm.	ASL-G/36
24 mm.	ASL-G/24
18 mm.	ASL-G/18

GROOVED FELT BOARDS

STANDARD SIZE (In mm Approx.)	PORTRAIT ART NO.	STANDARD SIZE (In mm Approx.)	LANDSCAPE ART NO.
300 x 450	AGB/P 3045	450 x 300	AGB/L 4530
450 x 600	AGB/P 4560	600 x 450	AGB/L 6045
600 x 900	AGB/P 6090	900 x 600	AGB/L 9060
900 x 1200	AGB/P 90120	1200 x 900	AGB/L 12090
1200 x 1200	AGB 120120		

FIGURES SET OF 100

SIZE OF FIGURES (In mm Approx.)	ART NO.
36 mm.	ASF-G/36
24 mm.	ASF-G/24
18 mm.	ASF-G/18

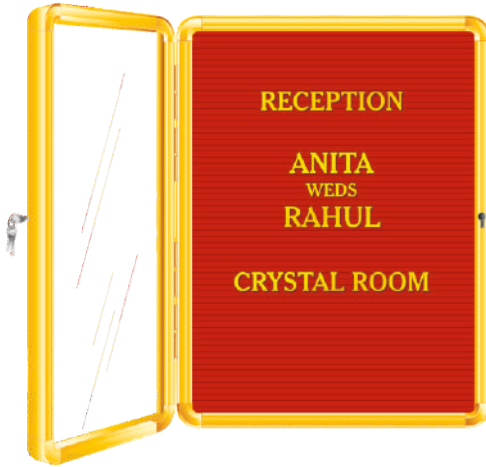

GROOVED FELT COVER NOTICE BOARDS

- ▶ Grooved notice Board.
- ▶ Acrylic sheet Front cover with golden aluminium frame.
- ▶ Lockable.
- ▶ Choice of three colors Red, Maroon & Black
- ▶ Provided with two keys.
- ▶ Golden letters and figures available.

STANDARD SIZE (In mm Approx.)	ART NO.
450 x 600	AGB/P/C 4560
600 x 900	AGB/P/C 6090
600 x 1200	AGB/P/C 60120
900 x 900	AGB/P/C 9090
900 x 1200	AGB/P/C 90120



GROOVED BOARD PEDESTAL STAND.

- ▶ Golden anodized aluminium pipe.
 - ▶ Stand with heavy golden base.
 - ▶ Available with or without castors
- Art No.: APSG**
Stand without castors.
- Art No.: APSG - C**
Stand with castors
Order AGB/P 6090 separately.





ALKOSIGN DISPLAY SYSTEMS

INTRODUCES

ALKOSIGN PEG BOARDS

SALIENT FEATURES

- ★ 27722 HOLES PER SQ. MTR. FACILITATES MORE WRITE UP COVERAGE
- ★ METRIC DIMENSION OF BOARDS & LETTERS
- ★ NARROW LETTERS ALLOW MORE INFORMATION
- ★ FOUR SIZES OF LETTERS 12MM. 18MM. 24MM. 36MM.
- ★ BOARDS AVAILABLE IN BLACK COLOR
- ★ LETTERS IN FOUR COLORS WHITE RED YELLOW & BLUE
- ★ CAN BE HUNG VERTICALLY OR HORIZONTALLY

ALKOSIGN DISPLAY / PEG BOARDS.

- ▶ Black perforated boards.
- ▶ Very popular boards to display information vertically as well as horizontally.
- ▶ Used in Offices, Hotels and many other public places.
- ▶ Four corner brackets provided to fix on the wall.
- ▶ Bigger sizes boards available in multiples of 150 mm.

PEDESTAL STAND

- ▶ Consists of a heavy base.
- ▶ Anodized Aluminium pipe of length 1800 mm. with two nylon holders which can be fixed on boards.
- ▶ Use one stand for boards up to 600mm. X 900mm.
- ▶ Use two stands for boards up to 900mm X 1200mm

STANDARD SIZE (In mm Approx.)	ART NO.
300 x 450	ASB 3045
450 X 600	ASB 4560
600 X 600	ASB 6060
600 X 900	ASB 6090
600 X 1200	ASB 60120

STANDARD SIZE (In mm Approx.)	ART NO.
600 X 1800	ASB 60180
900 X 900	ASB 9090
900 X 1500	ASB 90150
900 X 1800	ASB 90180

STANDARD SIZE (In mm Approx.)	ART NO.
1200 X 1200	ASB 120120
1200 X 1500	ASB 120150
1200 X 1800	ASB 120180
1200 X 2400	ASB 120240

ENGLISH LETTERS & FIGURES FOR PEG BOARDS

- ▶ ASL sets of 112 letters & ASF sets of 100 figures are available for Boards.
- ▶ Available in four sizes in White colour.
- ▶ All sets are packed in plastic boxes.



LETTERS SET OF 112		
AEIO	5 Each	20 Pcs.
CNRST	4 Each	20 Pcs.
BDFGHK	3 Each	18 Pcs.
LMPUWY	3 Each	18 Pcs.
JQV	2 Each	06 Pcs.
XZ	1 Each	02 Pcs.
.	-	10 Pcs.
'	-	04 Pcs.
-	-	05 Pcs.
,	-	02 Pcs.
()	-	04 Pcs.
& % /	1 Each	03 Pcs.
Total		112 Pcs

FIGURES SET OF 100		
150	14 Each	42 Pcs.
2	10 Each	10 Pcs.
346	8 Each	24 Pcs.
789	8 Each	24 Pcs.
	Total	100 Pcs.

SIZE OF LETTERS	SET OF 112 LETTERS ART NO.	SIZE OF FIGURES	SET OF 100 FIGURES ART NO.
12 mm	ASL 12	12 mm	ASF 12
18 mm	ASL 18	18 mm	ASF 18
24 mm	ASL 24	24 mm	ASF 24
36 mm	ASL 36	36 mm	ASF 36



**FIRST AID
BOX**



ACCIDENT ! DON'T PANIC

Keep Everything Your First Aid Kit Needs Handy

- ▶ Most elegant and economical first aid box available.
- ▶ Must for every residence, office or industrial establishment.
- ▶ Powder coated aluminium uprights for strength.
- ▶ Pivoting drawers for easy accessibility to medicines.
- ▶ All drawers have two partitions to divide into 2 sections or 3 sections.
- ▶ Consists of 1 drawer of height 125mm. Keep bottles or sprays etc.
- ▶ Plus two drawers of height 55mm. Keep tablet strips, ointments tubes, bandages etc.
- ▶ Lockable .
- ▶ Four holes provided in upright inside the box to fix on any wall with four screws and rawal plugs included



Art No : AFAB-1

Size of Box : 302mm (W) x 320mm (H) x 110mm. (D)

Art No.: AFAB-1

Size Of Box:

302mm (W) x 320mm (H) x 110mm (D)

Regd. Design No.: 262701





- ▶ Best small parts organizer system available.
- ▶ Store small electronic parts, stationary, hardware etc.
- ▶ Powder coated aluminium uprights for strength.
- ▶ Pivoting drawers for easy accessibility to parts stored.
- ▶ Four holes provided on the uprights inside the box to fix on any wall with four screw and rawal plugs included.
- ▶ Lockable.



Art No. ASPSB-6

Systems with 6 drawers of height 35 mm with two partitions to divide in two or three sections

Art No. ASPSB-4

Systems with 4 drawers of height 55 mm with two partitions to divide in two or three sections

Art No. ASPSB-3

Systems with 3 drawers of height 80 mm with two partitions to divide in two or three sections

Size of box :

302mm (w) x 320mm (h) x 110mm (d)

Art No. ASPSB-6

Art No. ASPSB-4

Art No. ASPSB-3

Size of box :

302mm (w) x 320mm (h) x 110mm (d)



Regd. Design No.: 262699



- ▶ Elegant and strong key box available.
- ▶ Very useful to store keys safely.
- ▶ Powder coated aluminium uprights for strength
- ▶ Pivoting front set of 30 keys for easy accessibility of last 15 keys.
- ▶ All key chain holding plates are numbered.
- ▶ All key holders have numbered paper inside the key chain to write any name.
- ▶ Key chain with two rings so the key always remains at the back and front can be read easily.
- ▶ Lockable for security.
- ▶ Four holes provided on the uprights inside the box to fix on any wall with four screw and rawal plugs provided.



Art No.: AEKB 15 (Key box to hold 15 keys)

Art No.: AEKB 45 (Key box to hold 45 keys)

Size of box :

302mm (W) x 320mm (H) x 110mm (D)

Art No.: AEKB 15
(Key box to hold 15 keys)

Art No.: AEKB 45
(Key box to hold 45 keys)

Size of box :

302mm (W) x 320mm (H) x 110mm (D)

Regd. Design No.: 262700



**LETTER
BOX**



- ▶ Strong and elegant A4 letter box.
- ▶ Lockable for security.
- ▶ Can take in big envelopes up to A4 size.
- ▶ Space to write name of society members or any individual.
- ▶ Paper stickers provided to write names.
- ▶ Can fit on the wall with four screw and rawal plugs included.
- ▶ Can also be used as **SUGGESTION BOX** in exhibitions or any establishment.
- ▶ Ten Big holes provided to see contents from outside.



Art No.: ALB-A4

Size of Box :

302mm (w) x 355mm (h) x 110mm (d)

Art No.: ALB-A4

Size of Box :

302mm (w) x 355mm (h) x 110 mm (d)

Regd. Design No.: 262698



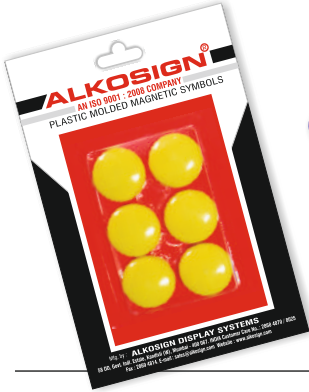

Blister packed
Colours :
Red, Green, Yellow & Blue

ALKOSIGN PLASTIC MOULDED MAGNETIC SYMBOLS

SHAPE	ART NO.	NO. OF SYMBOL PER PACK	SIZE
ROUND	AMSR 13	12 pcs	13 mm
ROUND	AMSR 20	6 pcs	20 mm
ROUND	AMSR 30	6 pcs	30 mm
ROUND	AMSR 40	6 pcs	40 mm



ASSORTED COLOURED PLASTIC MAGNETIC SYMBOLS

Sizes : 20 mm / 30 mm / 40 mm diameter
Four Nos. in each sizes and in four colours.
Art No. : AMS-ASS



ALKOSIGN

High Power

Special Neodym Magnetic Plastic Pymbol
With Easy Release

- ▶ Super strong Magnet.
- ▶ Perfect to use on boards to hold messages in various 4 colours.

30mm Round set of 6 pcs.

Art No.	AHPM-30R	AHPM-30Y	AHPM-30G	AHPM-30B	AHPM-30C
Colour	Red	Yellow	Green	Blue	Clear



ALKOSIGN High Power

Special Neodym Magnetic Push Pins

- ▶ Super strong Push Pin type Magnets.
- ▶ Clear Plastic.
- ▶ Set of 6 Pcs.
- ▶ Hold important messages or notes.



Art No. : AHPM-PP

ALKOSIGN BOARD DUSTER FOR WRITING BOARDS

A : Magnetic Board Duster holds on steel surface boards Provided with extra felt.

Colour : Grey Art No.: ABD 1

B : Non Magnetic Board Duster Does not hold on Steel surface.

Color : Black Art No.: ABD 3



Art No.: ABD- 3

Art No.: ABD -1



WHITE BOARD CLEANER

- ▶ Maintenance of white board.
- ▶ Clean white boards in offices, classrooms and board Rooms.
- ▶ Spray on the surface of the white board and clean with any soft cloth.
- ▶ Removes Residual Ink Dust & Dirt.
- ▶ CFC Free.
- ▶ Rapid Self Drying.



Art No.: AWBC-10

ACRYLIC WRITING DESK

- ▶ Most convenient to use on your table.
- ▶ Adjustable angle in fine steps.
- ▶ Paper holder on top.

Art No.: AWD

Size : 580mm X 400mm



MAGNETIC SHEET ENGLISH LETTERS (L) & FIGURES (F).

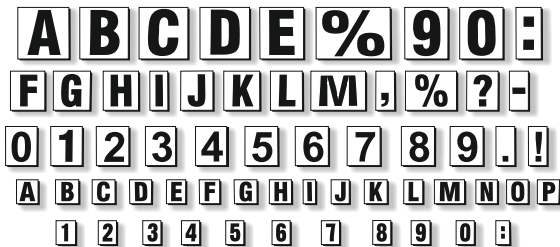

ART NO.	SET OF	SIZE
AML - 10	224 pcs	10 mm
AML - 20	224 pcs	20 mm
AML - 30	112 pcs	30 mm
AMF - 10	200 pcs	10 mm
AMF - 20	200 pcs	20 mm
AMF - 30	110 pcs	30 mm

PUSH PINS

- ▶ Used on felt or cork notice boards
- ▶ Modern design.
- ▶ Six colours : Green, Red, Blue, Yellow, White & black.
- ▶ 12 Push pins in one plastic container.
- ▶ 6 containers in one printed box.

Art No.: NBPP



STANDARD BOX OF KEY CHAINS DELUXE

Art No.: AKCD (Set of 20 Pcs.)

ASTRA CHROME PLATED PEN TRAY

- ▶ Chrome plated ABS plastic.
- ▶ Pen tray fits directly on Astra frames.

Art No.: PTAC (Chrome)



Art No.: PTA (Grey)



UNIVERSAL WHITE BOARD PEN TRAY

- ▶ Magnets incorporated.
- ▶ Fix directly on steel surface boards.
- ▶ Hang on a screw for laminate surface boards or walls.
- ▶ Holds 4 pens.

Art No.: AMPT- 4

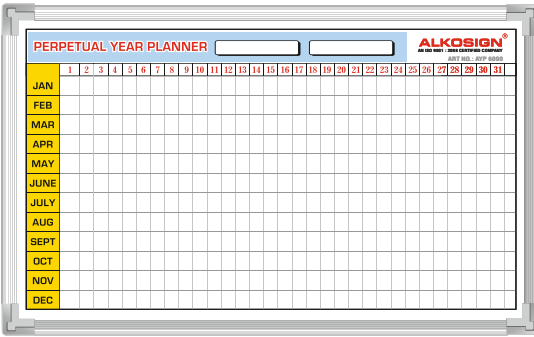

ALKOSIGN PRINTED YEARLY PLANNERS

- ▶ Hanging series aluminium frame-light weight.
- ▶ Acrylic resin coated steel surface.
- ▶ Accepts magnets.
- ▶ Most convenient perpetual yearly planner.
- ▶ Adjustable Magnetic Sunday blocks in red colour.

Size :
600mm. X 900mm.
Art No.: AYP 6090



Sunday blocks

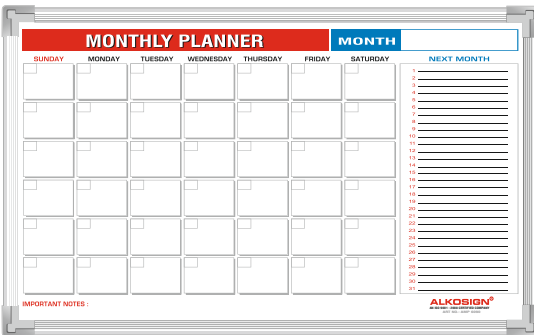

ALKOSIGN PRINTED MONTHLY PLANNERS

- ▶ Hanging series aluminium frame-light weight.
- ▶ Acrylic resin coated steel surface.
- ▶ Accepts magnets.
- ▶ Most convenient perpetual monthly planner.

Size :
600mm. X 900mm.
Art No.: AMP 6090

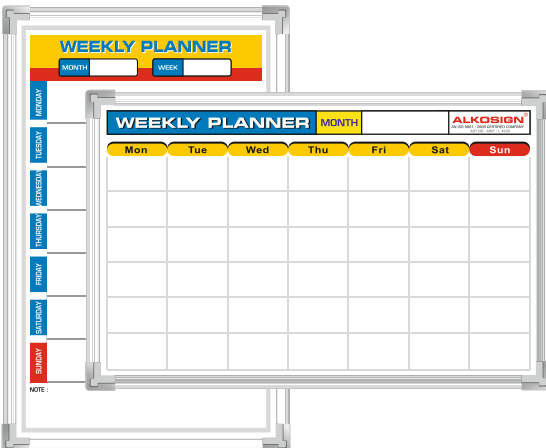

ALKOSIGN PRINTED WEEKLY PLANNERS

- ▶ Hanging series aluminium frame-light weight.
- ▶ Acrylic resin coated steel surface.
- ▶ Easy to write and wipe.
- ▶ Available in portrait & landscape

Size :
300mm. X 450mm. & 450mm. X 300mm.
Art No.: AWP 3045
Art No.: AWP/L 4530



ALKOSIGN® **ALKOSIGN DISPLAY SYSTEMS**

Corporate off :- 801, Embassy Chamber, 3rd Road,
Khar (W), Mumbai - 400 052. INDIA.
Tel.: 0091- 22- 2604 2168 / 7567/ 9165 / 5370
Fax.: 0091- 22-2605 1387

Works :- Bldg. No. 4, Sheetal Supreme Ind. Complex,
Survey No. 75, H. No.2, Waliv, Satalvali Road, Vasai (E),
Dist. Palghar- 401208. INDIA
Tel.: 0250-645 7250 (16 Lines)
Email : sales@alkosign.com Web Site : www.alkosign.com

This Catalogue should not be reproduced Wholly or Partially as it is covered under Copyright Act.

www.alkosign.com

STOCKIST